



DEUTSCHE SCHWEIZ

TRAUFFER AG / TRAUFFER MARKIERUNGS AG

Rothornstrasse 11
CH-3855 Brienz

Dorfstrasse 3
CH-5040 Schöftland

Kernserstrasse 3
CH-6056 Kägiswil

TRAUFFER AG MARKIERUNGEN

Feldmattstrasse 32
CH-6032 Emmen

Zürcherstrasse 282
CH-8500 Frauenfeld

Industriestrasse 86
CH-7310 Bad Ragaz

F. WYSSBROD AG

Büttenbergweg 13
CH-2542 Pieterlen

Garwidenstrasse 12
CH-4702 Oensingen

Industriestrasse 97
CH-3900 Brig/Gamsen

Dammweg 17
CH-3073 Gümligen

SUISSE ROMANDE

TRAUFFER MARQUAGE SA

Chemin de Praz-Lau 3
CH-1033 Cheseaux-sur-Lausanne

MARC ANSERMOZ SA

Rte d'Evian 88
CH-1860 Aigle

Grand rue 48
CH-1896 Vouvry VS

U. WYSSBROD SA

Case postale 52
CH-2345 Les Breuleux



Alle Betriebe der Trauffer Group sind ISO-zertifiziert und orientieren sich in der Ausführung an höchsten Standards.
Unsere Arbeit dient vor allem zwei Grundsätzen:
der bestmöglichen Sicherheit unserer Mitarbeitenden und der Zufriedenheit unserer Kunden – seit 1934.



Toutes les entreprises du Groupe Trauffer sont certifiées ISO et s'orientent, dans l'exécution de leurs services, sur les standards les plus exigeants.
Notre travail sert avant tout deux objectifs fondamentaux: la meilleure sécurité possible pour nos collaborateurs et la satisfaction de nos clients – depuis 1934.



WWW.TRAUFFER-GROUP.CH

Kostenlose Service-Nummer · Numéro gratuit à votre disposition **0800 10 00 10**



EFFIZIENT, RENTABEL, EINFACH ZU INSTALLIEREN - DER FUNDAMENTPFAHL FERRADIX®

Mit dem Fundamentpfahl Ferradix® bieten wir Ihnen die perfekte Lösung für die Verankerung von z. B. Tragkonstruktionen für Schilder und Tafeln und von Pfosten und Zäunen. Die einfache Montage kann wahlweise durch unser Fachpersonal ausgeführt werden, oder Sie haben die Möglichkeit, den Fundamentpfahl selbst zu installieren. Entsprechendes Gerät kann ebenfalls über die Trauffer Group bezogen werden.

Schnell montiert, beständig, vielseitig und praktisch im Unterhalt – der Fundamentpfahl Ferradix®.

Gerne beraten wir Sie individuell nach Ihren Anforderungen.

Nehmen Sie für Ihre Beratung mit dieser Nummer kostenlos Kontakt mit uns auf: **0800 10 00 10**.

EFFICIENT, RENTABLE, FACILE À INSTALLER - LE PIEU POUR FONDATION «FERRADIX®»

Avec le pieu pour fondation «Ferradix®» nous vous proposons une solution parfaite pour l'ancrage de différents supports, par exemple pour les mâts de signalisation, de panneau d'affichage, indicateurs pédestre et touristique, de mobilier urbain, de caissette à journaux, balisage de gazoduc etc. ou encore de clôtures. Son montage facile peut être effectué par notre personnel spécialisé ou par vos propres moyens. Le matériel correspondant peut alors également être fourni par le Groupe Trauffer.

Rapidement installé, résistant, polyvalent, d'un entretien facile – le pieu de fondation «Ferradix®».

Nous vous conseillons volontiers individuellement, selon vos exigences. Veuillez prendre contact avec nos conseillers au numéro gratuit **0800 10 00 10**.



**TECHNISCHE INFORMATIONEN
 TRAGKONSTRUKTIONEN
 INFORMATION TECHNIQUE SUR
 LES CONSTRUCTIONS DE SUPPORT**

Material / Matériau

- Stahl / Acier

Oberfläche / Traitement de Surface

- Feuerverzinkt / Galvanisée à chaud

Mehrpreis / Supplément

- Befestigungen feuerverzinkt und wahlweise in RAL lackiert oder pulverbeschichtet.
- Fixations galvanisées à chaud et – au choix – laquage RAL ou revêtement par poudrage

**TECHNISCHE INFORMATIONEN
 BEFESTIGUNGEN
 INFORMATION TECHNIQUE SUR
 LES FIXATIONS**

Material / Matériau

- Stahl / Acier

Oberfläche / Traitement de Surface

- Feuerverzinkt / Galvanisée à chaud

Mehrpreis / Supplément

- Befestigungen feuerverzinkt und wahlweise in RAL lackiert oder pulverbeschichtet.
- Fixations galvanisées à chaud et – au choix – laquage RAL ou revêtement par poudrage

Schraubenmaterial / Matériel pour la visserie

- Rostfreier Stahl / Acier inoxydable

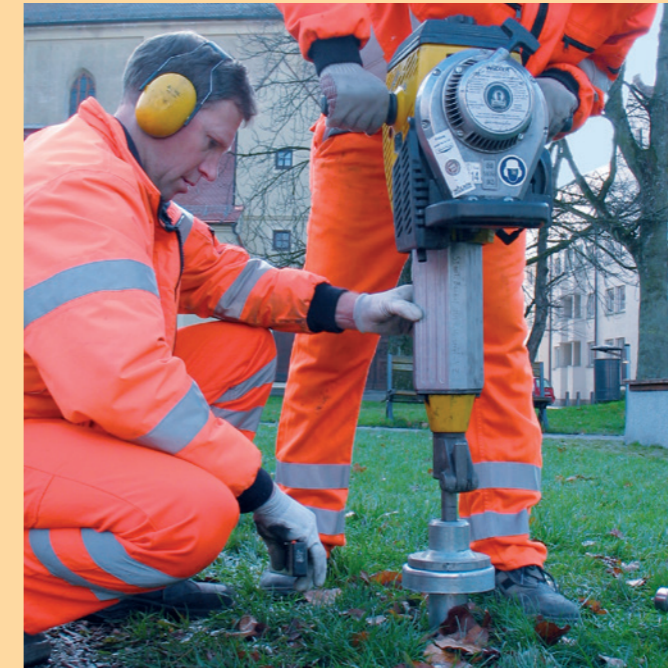

**TRAGKONSTRUKTIONEN UND
 BEFESTIGUNGEN FÜR JEDE UMGEBUNG**

Auf den folgenden Seiten stellen wir Ihnen unser Produktangebot im Bereich Tragkonstruktionen und Befestigungen vor. Sie haben eine Vielzahl von Möglichkeiten für die hochwertige und langlebige Befestigung von Schildern und Tafeln in verschiedensten Umgebungen.

Gerne beraten wir Sie persönlich und bitten Sie um Kontaktaufnahme über die kostenlose nationale Nummer **0800 10 00 10**.

**CONSTRUCTIONS DE SUPPORT
 ET DE FIXATION DANS TOUS LES
 ENVIRONNEMENTS.**

Sur les pages suivantes, nous vous présentons notre offre de produits dans les domaines des constructions de supports et de fixations. Vous avez de multiples possibilités pour la fixation de haute qualité durable pour panneaux et signalétique dans les environnements les plus divers.

Nous vous conseillons volontiers individuellement et vous invitons à nous contacter au numéro national gratuit **0800 10 00 10**.



ROHRRAHMENSTÄNDER
SUPPORTS POUR SIGNAUX

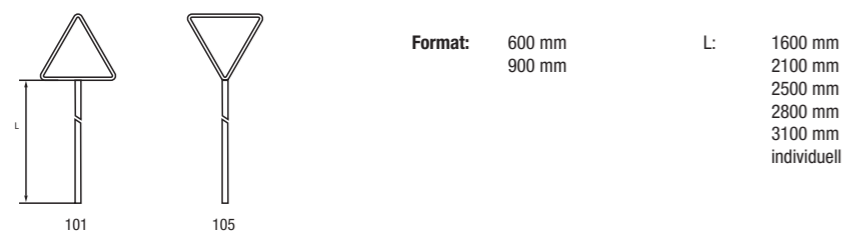

Format: 600 mm
900 mm

L: 1600 mm
2100 mm
2500 mm
2800 mm
3100 mm
individuell

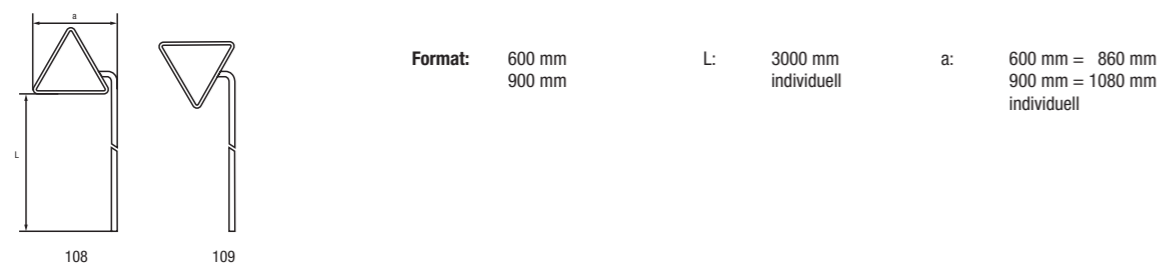

Format: 600 mm
900 mm

L: 3000 mm
individuell

a: 600 mm = 860 mm
900 mm = 1080 mm
individuell

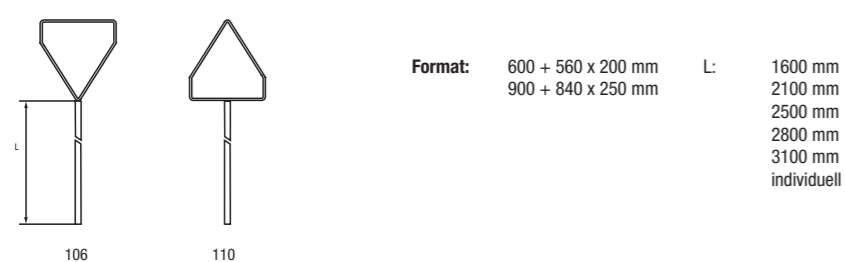

Format: 600 + 560 x 200 mm
900 + 840 x 250 mm

L: 1600 mm
2100 mm
2500 mm
2800 mm
3100 mm
individuell

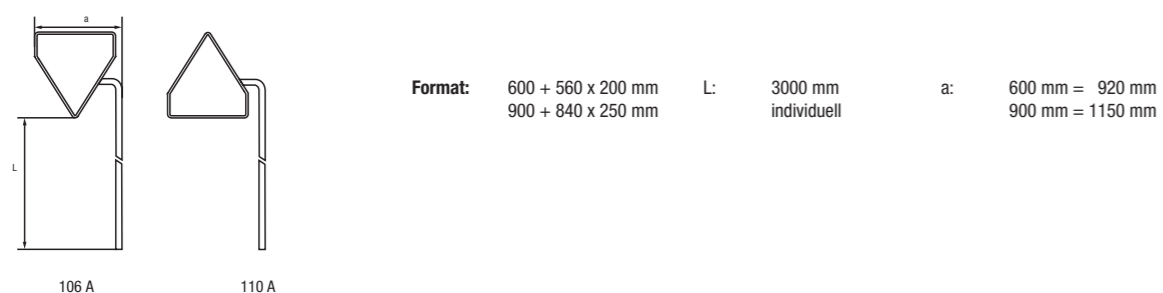

Format: 600 + 560 x 200 mm
900 + 840 x 250 mm

L: 3000 mm
individuell

a: 600 mm = 920 mm
900 mm = 1150 mm

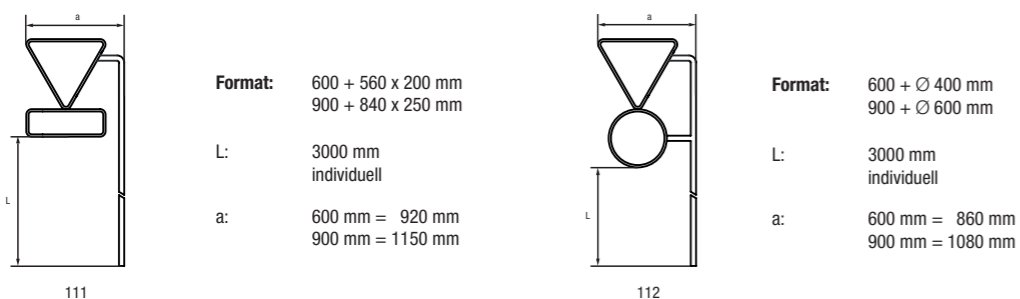

Format: 600 + 560 x 200 mm
900 + 840 x 250 mm

L: 3000 mm
individuell

a: 600 mm = 920 mm
900 mm = 1150 mm

Format: 600 + Ø 400 mm
900 + Ø 600 mm

L: 3000 mm
individuell

a: 600 mm = 860 mm
900 mm = 1080 mm

ROHRRAHMENSTÄNDER
SUPPORTS POUR SIGNAUX

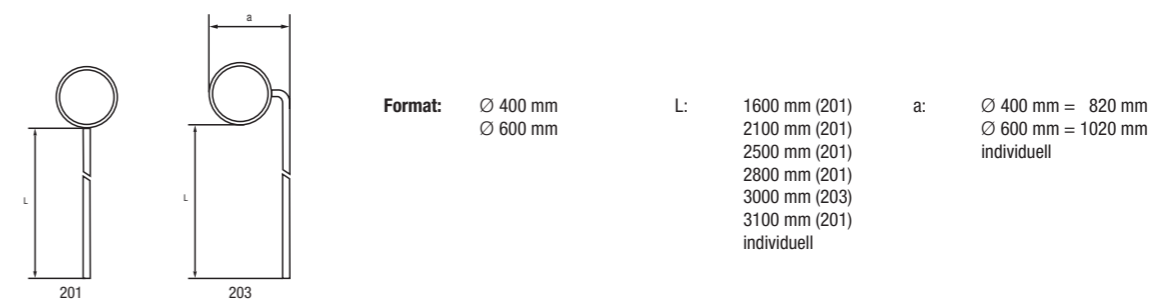

Format: Ø 400 mm
Ø 600 mm

L: 1600 mm (201)
2100 mm (201)
2500 mm (201)
2800 mm (201)
3000 mm (203)
3100 mm (201)
individuell

a: Ø 400 mm = 820 mm
Ø 600 mm = 1020 mm
individuell

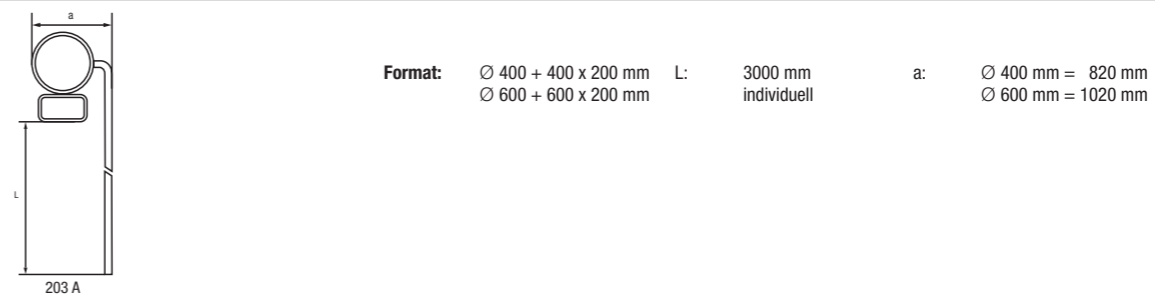

Format: Ø 400 + 400 x 200 mm
Ø 600 + 600 x 200 mm

L: 3000 mm
individuell

a: Ø 400 mm = 820 mm
Ø 600 mm = 1020 mm

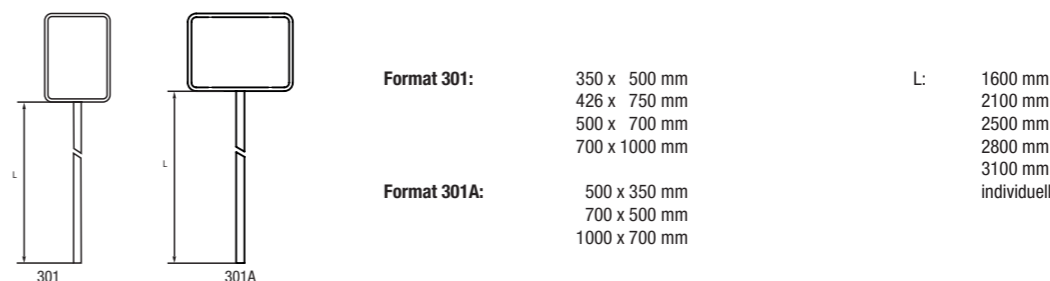

Format 301: 350 x 500 mm
426 x 750 mm
500 x 700 mm
700 x 1000 mm

Format 301A: 500 x 350 mm
700 x 500 mm
1000 x 700 mm

L: 1600 mm
2100 mm
2500 mm
2800 mm
3100 mm
individuell

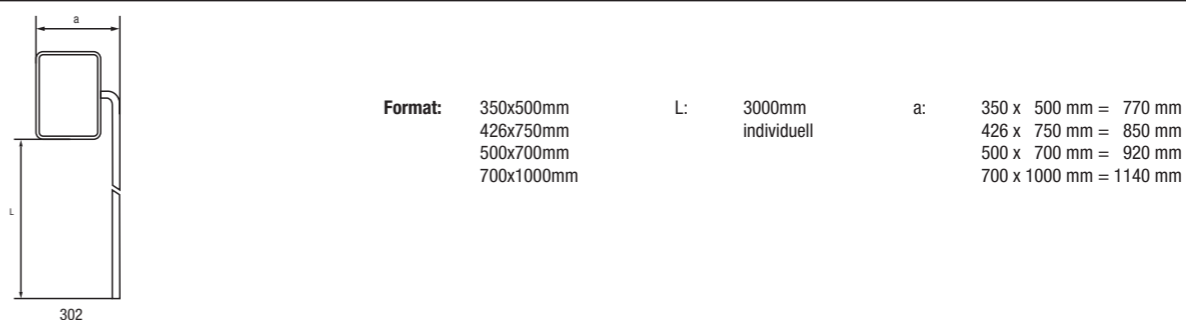

Format: 350x500mm
426x750mm
500x700mm
700x1000mm

L: 3000mm
individuell

a: 350 x 500 mm = 770 mm
426 x 750 mm = 850 mm
500 x 700 mm = 920 mm
700 x 1000 mm = 1140 mm

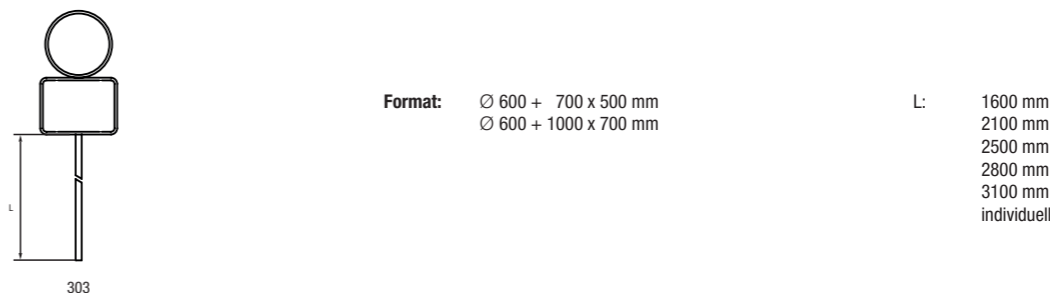

Format: Ø 600 + 700 x 500 mm
Ø 600 + 1000 x 700 mm

L: 1600 mm
2100 mm
2500 mm
2800 mm
3100 mm
individuell

ROHRRAHMENSTÄNDER
SUPPORTS POUR SIGNAUX

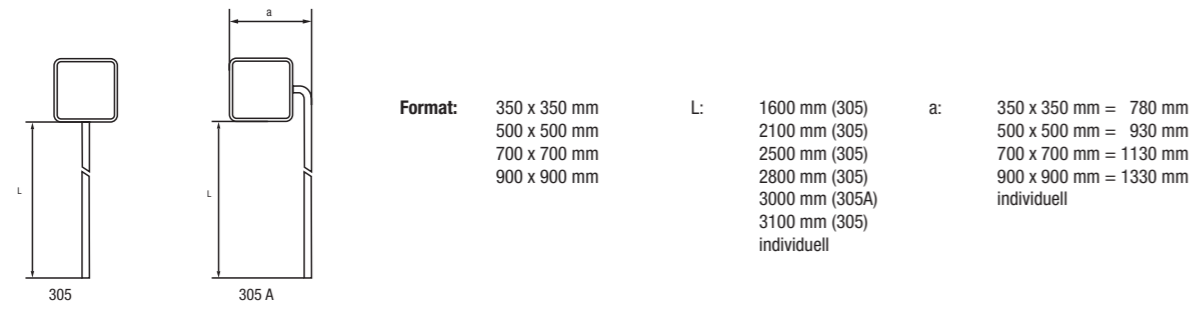

Format: 350 x 350 mm
500 x 500 mm
700 x 700 mm
900 x 900 mm

L: 1600 mm (305)
2100 mm (305)
2500 mm (305)
2800 mm (305)
3000 mm (305A)
3100 mm (305)
individuell

a: 350 x 350 mm = 780 mm
500 x 500 mm = 930 mm
700 x 700 mm = 1130 mm
900 x 900 mm = 1330 mm
individuell

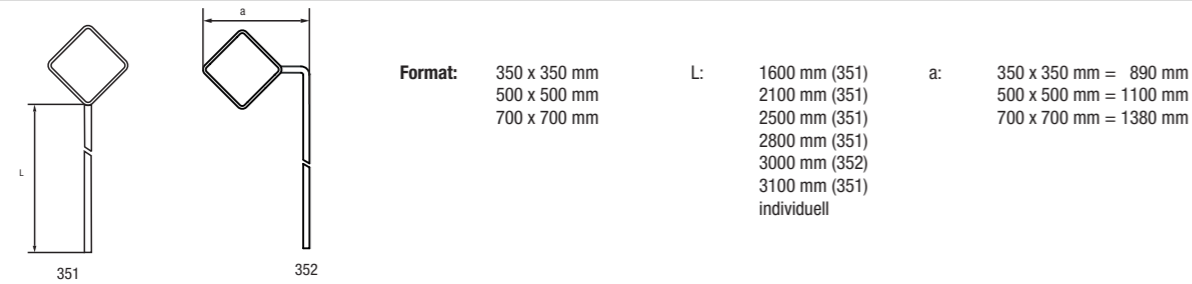

Format: 350 x 350 mm
500 x 500 mm
700 x 700 mm

L: 1600 mm (351)
2100 mm (351)
2500 mm (351)
2800 mm (351)
3000 mm (352)
3100 mm (351)
individuell

a: 350 x 350 mm = 890 mm
500 x 500 mm = 1100 mm
700 x 700 mm = 1380 mm

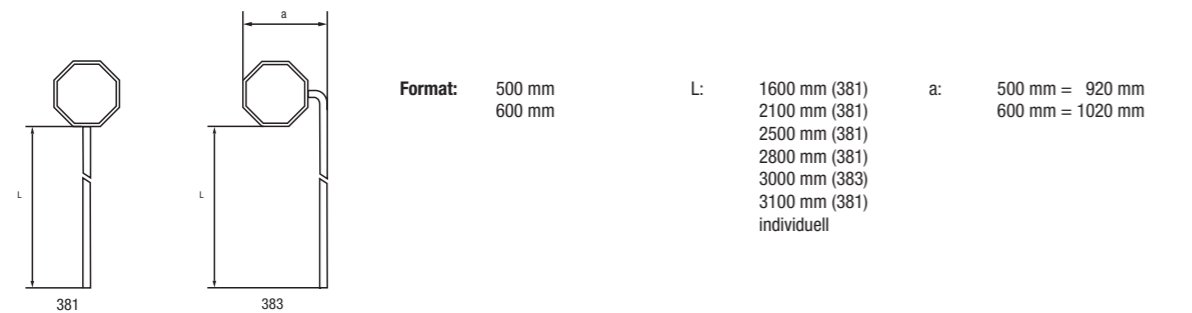

Format: 500 mm
600 mm

L: 1600 mm (381)
2100 mm (381)
2500 mm (381)
2800 mm (381)
3000 mm (383)
3100 mm (381)
individuell

a: 500 mm = 920 mm
600 mm = 1020 mm

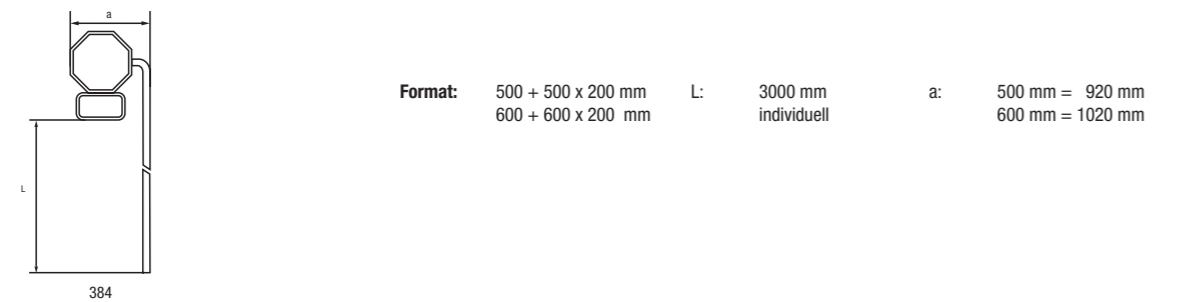

Format: 500 + 500 x 200 mm
600 + 600 x 200 mm

L: 3000 mm
individuell

a: 500 mm = 920 mm
600 mm = 1020 mm

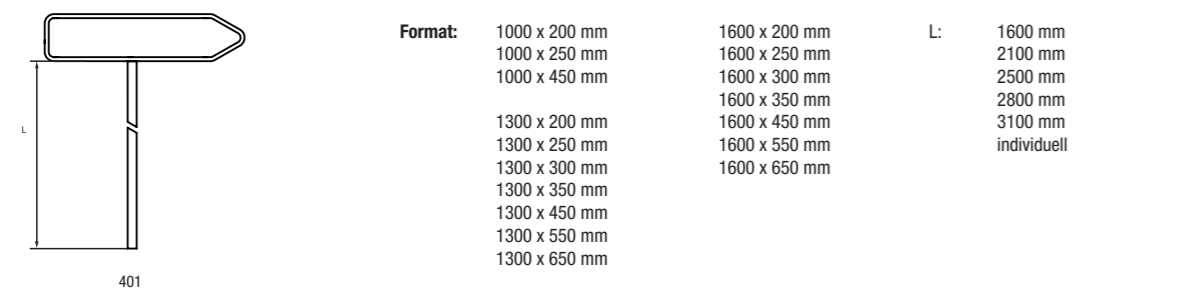

Format: 1000 x 200 mm
1000 x 250 mm
1000 x 450 mm
1300 x 200 mm
1300 x 250 mm
1300 x 300 mm
1300 x 350 mm
1300 x 450 mm
1300 x 550 mm
1300 x 650 mm

L: 1600 mm
2100 mm
2500 mm
2800 mm
3100 mm
individuell

a: 1600 mm
2100 mm
2500 mm
2800 mm
3100 mm
individuell

ROHRRAHMEN MIT JORDAHLSCHIENE
SUPPORTS POUR SIGNAUX AVEC GLISSIÈRE JORDAHL



151

Format: 600 mm
900 mm
1200 mm
1500 mm

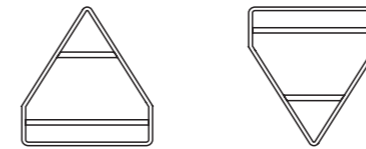

152

Format: 600 + 560 x 200 mm
900 + 840 x 250 mm
1200 + 1140 x 400 mm
1500 + 1440 x 500 mm

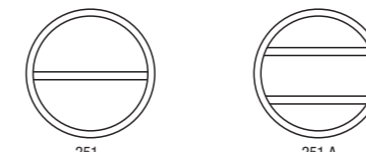

251

251 A

Format: Ø 400 mm (251)
Ø 600 mm (251A)
Ø 900 mm (251A)
Ø 1200 mm (251A)

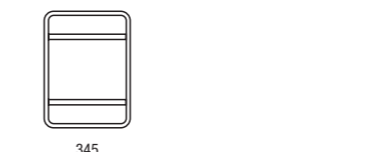

345

Format: 350 x 500 mm
426 x 750 mm
500 x 700 mm
700 x 1000 mm
900 x 1250 mm
980 x 1355 mm

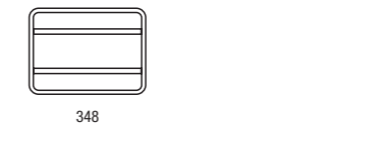

348

Format: 50 x 350 mm
700 x 500 mm
900 x 700 mm
1000 x 700 mm

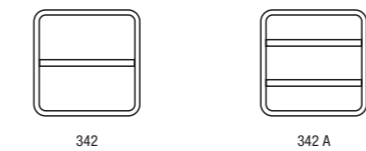

342

342 A

Format: 350 x 350 mm (342)
500 x 500 mm (342A)
600 x 600 mm (342A)
700 x 700 mm (342A)
900 x 900 mm (342A)
1200 x 1200 mm (342A)



361

361 A

Format: 350 x 350 mm (361)
500 x 500 mm (361A)
700 x 700 mm (361A)
900 x 900 mm (361A)



390

Format: 600 mm
500 mm
900 mm

**ROHRRAHMEN MIT JORDALSCHIENE
SUPPORTS POUR SIGNAUX JORDAL**

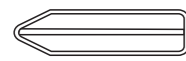

421

Format:
1000 x 200 mm (421)
1000 x 250 mm (421A)
1000 x 450 mm (421A)

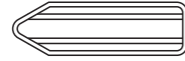

421 A

1300 x 200 mm (421)
1300 x 250 mm (421A)
1300 x 300 mm (421A)
1300 x 350 mm (421A)
1300 x 450 mm (421A)
1300 x 550 mm (421A)
1300 x 650 mm (421A)

1600 x 200 mm (421)
1600 x 250 mm (421A)
1600 x 300 mm (421A)
1600 x 350 mm (421A)
1600 x 450 mm (421A)
1600 x 550 mm (421A)
1600 x 650 mm (421A)

1900 x 300 mm (421A)
1900 x 350 mm (421A)
1900 x 450 mm (421A)
1900 x 550 mm (421A)
1900 x 650 mm (421A)

**ROHRRAHMEN FÜR SEITLICHE BEFESTIGUNG MIT BANDBRIDE
(ERWEITERBAR DURCH ROHRBRIDE)
SUPPORTS POUR FIXATION LATÉRALE AVEC BANDE EN ACIER
(OPTIONAL AVEC BRIDE)**

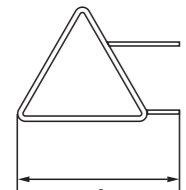
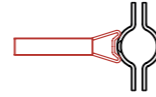

153

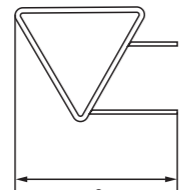

153 A

Format:
600 mm
900 mm

a:
600 mm = 720 mm
900 mm = 1030 mm
individuell

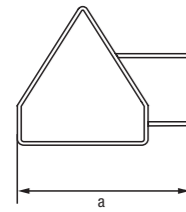

154

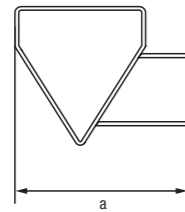

154 A

Format:
600 + 560 x 200 mm
900 + 840 x 250 mm

a:
600 mm = 670 mm
900 mm = 950 mm
individuell

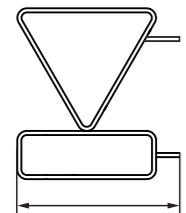

155

Format:
600 + 560 x 200 mm
900 + 840 x 250 mm

a:
600 mm = 670 mm
900 mm = 950 mm
individuell

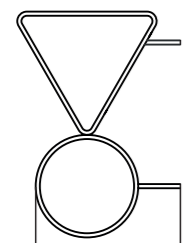

156

Format:
600 + Ø 400 mm
900 + Ø 600 mm

a:
600 mm = 720 mm
900 mm = 1030 mm
individuell

**ROHRRAHMEN FÜR SEITLICHE BEFESTIGUNG
MIT BANDBRIDE
(ERWEITERBAR DURCH ROHRBRIDE)
SUPPORTS POUR FIXATION LATÉRALE
AVEC BANDE EN ACIER
(OPTIONAL AVEC BRIDE)**

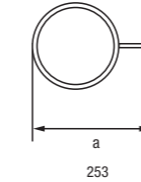
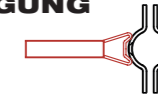

253

Format:
Ø 400 mm (253)
Ø 600 mm (253A)

a:
Ø 400 mm = 510 mm
Ø 600 mm = 770 mm
individuell

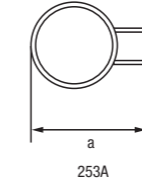

253A

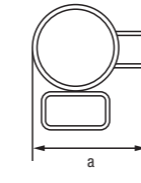

254

Format:
Ø 400 + 400 x 200 mm
Ø 600 + 600 x 200 mm

a:
Ø 400 mm = 510 mm
Ø 600 mm = 770 mm
individuell

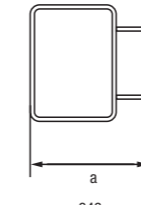

346

Format:
350 x 500 mm
426 x 750 mm
500 x 700 mm
700 x 1000 mm
900 x 1250 mm

a:
350 x 500 mm = 455 mm
426 x 750 mm = 530 mm
500 x 700 mm = 605 mm
700 x 1000 mm = 805 mm
900 x 1250 mm = 1005 mm
individuell

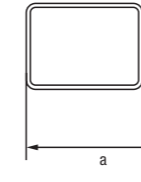

349

Format:
500 x 350 mm
700 x 500 mm
1000 x 700 mm

a:
500 x 350 mm = 605 mm
700 x 500 mm = 805 mm
1000 x 700 mm = 1105 mm
individuell

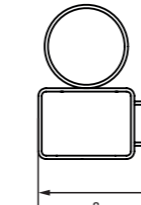

304

Format:
Ø 600 + 700 x 500 mm
Ø 600 + 1000 x 700 mm

a:
700 x 500 mm = 805 mm
1000 x 700 mm = 1105 mm
individuell

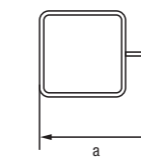

343

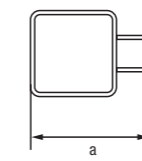

343A

Format:
350 x 350 mm (343)
500 x 500 mm (343A)
700 x 700 mm (343A)
900 x 900 mm (343A)

a:
350 x 350 mm = 455 mm
500 x 500 mm = 605 mm
700 x 700 mm = 805 mm
900 x 900 mm = 1005 mm
individuell

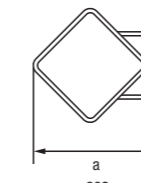

362

Format:
350 x 350 mm
500 x 500 mm
700 x 700 mm

a:
350 x 350 mm = 580 mm
500 x 500 mm = 850 mm
700 x 700 mm = 1100 mm
individuell

**ROHRRAHMEN FÜR SEITLICHE BEFESTIGUNG MIT BANDBRIDE
(ERWEITERBAR DURCH ROHRBRIDE)
SUPPORTS POUR FIXATION LATÉRALE AVEC BANDE EN ACIER
(OPTIONAL AVEC BRIDE)**

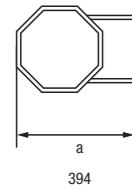
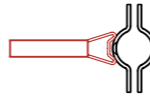

Format: 500 mm
600 mm

a: 500 mm = 605 mm
600 mm = 705 mm
individuell

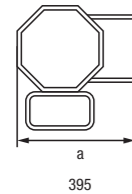

Format: 500 + 500 x 200 mm
600 + 600 x 200 mm

a: 500 mm = 605 mm
600 mm = 705 mm
individuell

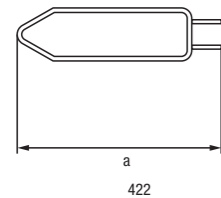

Format: 1000 x 200 mm
1000 x 250 mm
1000 x 300 mm
1000 x 450 mm

1300 x 200 mm
1300 x 250 mm
1300 x 300 mm
1300 x 350 mm
1300 x 450 mm
1300 x 550 mm
1300 x 650 mm

a: 1000 mm = 1080 mm
1300 mm = 1380 mm
1600 mm = 1680 mm
individuell

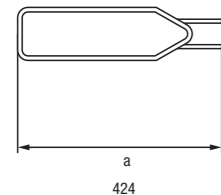

1600 x 200 mm
1600 x 250 mm
1600 x 300 mm
1600 x 350 mm
1600 x 450 mm
1600 x 550 mm
1600 x 650 mm

**ROHRRAHMEN MIT PLUG-SYSTEM
SUPPORTS POUR SIGNAUX AVEC SYSTÈME PLUG**



**TRAUFFER
GROUP**

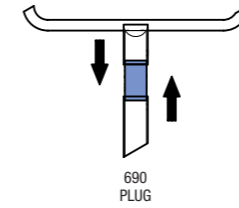

Format: Ø 60 mm

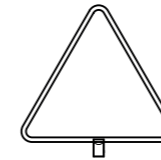

101S

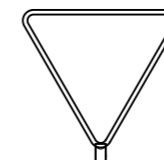

105S

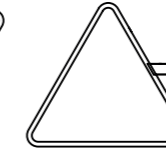

108S

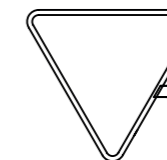

109S

Format: 600 mm
900 mm

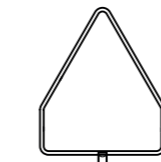

110S

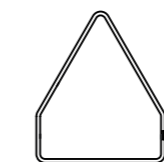

110AS

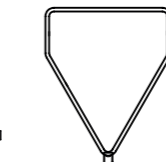

106S

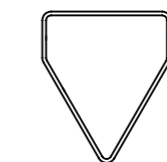

106AS

Format: 600 + 560 x 200 mm
900 + 840 x 250 mm



155S

Format: 600 + 560 x 200 mm
900 + 840 x 250 mm

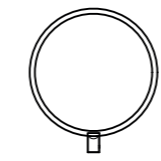

201S

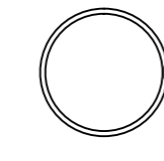

203S

Format: Ø 400 mm
Ø 600 mm

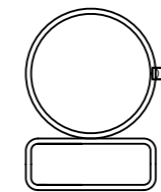

254S

Format: Ø 400 + 400 x 200 mm
Ø 600 + 600 x 200 mm

WWW.TRAUFFER-GROUP.CH

Kostenlose Service-Nummer · Numéro gratuit à votre disposition **0800 10 00 10**

ROHRRAHMEN MIT PLUG-SYSTEM
SUPPORTS POUR SIGNAUX AVEC SYSTÈME PLUG

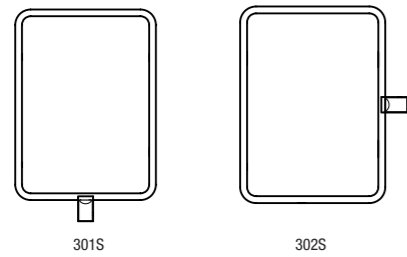

Format: 350 x 500 mm
426 x 750 mm
500 x 700 mm
700 x 1000 mm

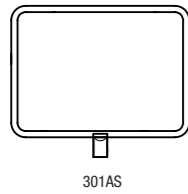

Format: 500 x 350 mm
700 x 500 mm
1000 x 700 mm

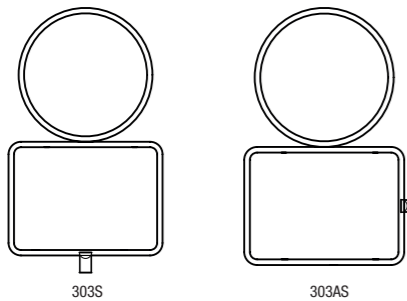

Format: Ø 600 + 700 x 500 mm
Ø 600 + 1000 x 700 mm

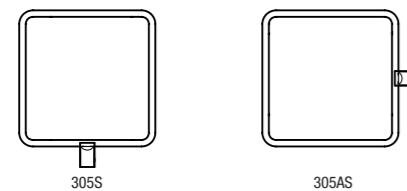

Format: 350 x 350 mm
500 x 500 mm
700 x 700 mm

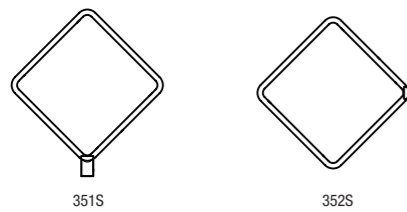

Format: 350 x 350 mm
500 x 500 mm
700 x 700 mm

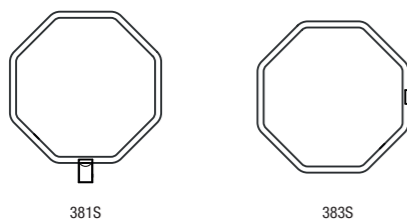

Format: 500 mm
600 mm

ROHRRAHMEN MIT PLUG-SYSTEM
SUPPORTS POUR SIGNAUX AVEC SYSTÈME PLUG

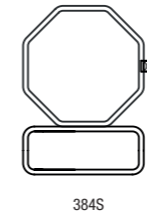

Format: 500+500x200mm
600+600x200mm

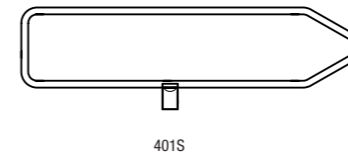

Format: 1000x200mm
1000x250mm
1000x450mm
1300x200mm
1300x250mm
1300x300mm
1300x350mm
1300x450mm
1300x550mm
1300x650mm
1600x250mm
1600x300mm
1600x350mm
1600x450mm
1600x550mm
1600x650mm

ROHRRAHMEN MIT JORDAHLSCHIENE (FLACHEISEN)
SUPPORTS POUR SIGNAUX AVEC GLISSIÈRE JORDAHL (CADRES EN FER)

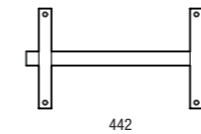

Format: 360 x 120 mm
400 x 200 mm
500 x 200 mm
540 x 180 mm
560 x 200 mm
600 x 200 mm
840 x 250 mm
900 x 300 mm

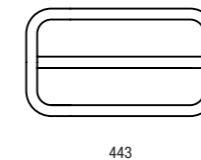

Format: 400 x 200 mm
500 x 200 mm
560 x 200 mm
600 x 200 mm
840 x 250 mm
900 x 300 mm
1200 x 400 mm
1500 x 500 mm

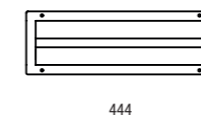

Format: 400 x 200 mm
500 x 200 mm
560 x 200 mm
600 x 200 mm
840 x 250 mm
900 x 300 mm

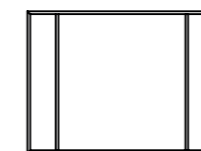
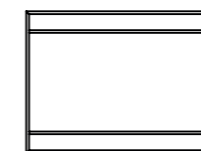

Format: individuell
< 5 m² 28/15 kleine Jordahlschiene / petite glissière Jordahl
> 5 m² 34/17 grosse Jordahlschiene / grande glissière Jordahl

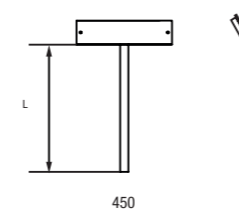

Signalträger für Autonummern
Support en fer plat pour plaquettes de numéros de voitures
Format: 400 x 200 mm
500 x 200 mm
560 x 200 mm
600 x 200 mm
840 x 250 mm
900 x 300 mm
L: 750 mm
individuell

ROHRRAHMEN MIT PLUG-SYSTEM
SUPPORTS POUR SIGNAUX AVEC SYSTÈME PLUG

ROHRRAHMEN MIT JORDAHLSCHIENE (FLACHEISEN)
SUPPORTS POUR SIGNAUX AVEC GLISSIÈRE JORDAHL (CADRES EN FER)

**HALTERUNGEN
FIXATIONS**

**BRIDEN FÜR JORDAHLSCIENE
BRIDES POUR GLISSIÈRE JORDAHL**



600
28/15



601
34/17

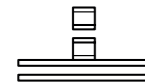

602
28/15

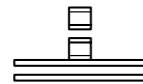

603
34/17

28/15 kleine Jordahlschiene / petite glissière Jordahl
34/17 grosse Jordahlschiene / grande glissière Jordahl

Format: Ø 60 mm
Ø 76 mm
Ø 83 mm
Ø 89 mm
Ø 102 mm
Ø 108 mm
Ø 114 mm
Ø 121 mm
Ø 127 mm
Ø 133 mm
Ø 140 mm
Ø 152 mm
individuell

**BRIDEN FÜR SEITLICHE BEFESTIGUNG
BRIDES POUR FIXATION LATÉRALE**

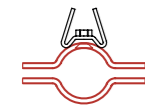

604

**DOPPELROHRBRIDE
BRIDE DOUBLE**

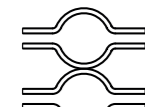

605

Format: Ø 60 mm
Ø 76 mm
Ø 83 mm
Ø 89 mm
individuell

**BÜGEL FÜR BANDBEFESTIGUNG (JORDAHL)
BRIDE POUR FIXATION AVEC BANDE EN ACIER (JORDAHL)**



610
28/15



611
34/17

28/15 kleine Jordahlschiene / petite glissière Jordahl
34/17 grosse Jordahlschiene / grande glissière Jordahl

**BRIDE FÜR WANDMONTAGE
BRIDE POUR FIXATION MURALE**



621

Format: Ø 60 mm
Ø 76 mm
Ø 83 mm
Ø 89 mm
individuell

**WANDBEFESTIGUNG FÜR SEITLICHE MONTAGE
BRIDE DE FIXATION MURALE POUR SUPPORTS AVEC FIXATION LATÉRALE**



620

**STANDROHRE
POTEAUX**

**STANDROHR OBEN ZUGESCHWEISST
POTEAUX SOUDÉ EN HAUT**



650

Format: Ø 60 mm Ø 76 mm Ø 83 mm Ø 89 mm

1000 mm	3000 mm	3000 mm	3600 mm
1500 mm	3300 mm	3300 mm	4000 mm
2000 mm	3600 mm	3600 mm	individuell
2400 mm	4000 mm	4000 mm	
2700 mm	individuell	individuell	
3000 mm			
3300 mm			
3600 mm			
4000 mm			
individuell			

**STANDROHR FÜR PLUG-SYSTEM
POTEAUX AVEC SYSTEM PLUG**



651



652
mit Kunststoffdeckel
avec couvercle



653



660
Kunststoffdeckel Ø 60 mm
Couvercle Ø 60 mm

Format: Ø 60 mm

1000 mm
1500 mm
2000 mm
2400 mm
2700 mm
3000 mm (653)
3300 mm
3600 mm
4000 mm
individuell

**STANDROHR FÜR FLANSCHBEFESTIGUNG (RUND)
POTEAUX AVEC PLATINE (RONDE)**



Ø 125 mm



657
oben zugeschweisst
soudé en haut



658
für Plug-System
pour system Plug



659
für Plug-System
mit Kunststoffdeckel
pour system Plug
avec couvercle

Format: Ø 60 mm

1500 mm
2000 mm
2400 mm
2700 mm
3000 mm
individuell

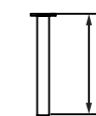

672
Bodenhülse mit Flansch
Douille avec flasque

Format 672: Ø-Aussen/Extérieur
Ø 60mm

L = 300 mm
L = 400 mm
L = 500 mm

**STANDROHR FÜR FLANSCHBEFESTIGUNG (ECKIG)
POTEAUX AVEC PLATINE (CARRÉ)**



150 x 150 mm



654
oben zugeschweisst
soudé en haut



655
für Plug-System
pour system Plug



656
für Plug-System
mit Kunststoffdeckel
pour system Plug
avec couvercle

Format: Ø 60 mm

1500 mm
2000 mm
2400 mm
2700 mm
3000 mm
individuell

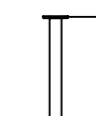

671
Bodenhülse mit Flansch
Douille avec flasque

Format 671: Ø-Aussen/Extérieur
Ø 60mm

L = 300 mm
L = 400 mm
L = 500 mm

**VERANKERUNGEN UND FUNDAMENTE
FONDATIONS POUR SIGNAUX**

**FUNDAMENTSOCKEL KOMPLETT (INKL. ZUBEHÖR)
SOCLES DE FONDATION PRÉFABRIQUÉS (ACCESSOIRES INCL.)**



674

Format:	FS60	220 x 220 x 500 mm
	FS76	300 x 300 x 600 mm
	FS89	300 x 300 x 600 mm

**STAHLFUNDAMENT KOMPLETT (INKL. ZUBEHÖR)
SOCLES DE FONDATION EN ACIER (ACCESSOIRES INCL.)**

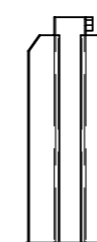

673

Format:	Ø 60 mm	195 x 195 x 500 mm
	Ø 60 mm	195 x 195 x 300 mm

**ZUBEHÖR
ACCESSOIRES**



537623



210010

Format 210010:	Ø 60 mm
	Ø 76 mm
	Ø 89 mm

*** FUNDAMENTPFAHL FERRADIX® - SIEHE SYSTEMLÖSUNGEN**
*** PIEU FERRADIX® - VOIR SYSTEMES ET SOLUTIONS**

**BODENHÜLSEN
DOUILLE**



150 x 150 mm



671
Bodenhülse mit Flansch
Douille avec flasque



Ø 125 mm

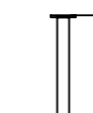

672
Bodenhülse mit Flansch
Douille avec flasque



670
Bodenhülse
Douille

Format 671/672:	Ø-Aussen/Extérieur	Ø 60 mm
	L = 300 mm	
	L = 400 mm	
	L = 500 mm	

Format 670:	Ø-Innen/Intérieur	
	Ø 60 mm	L = 300 mm
	Ø 60 mm	L = 500 mm
	Ø 76 mm	L = 600 mm
	Ø 89 mm	L = 600 mm
	individuell	

**Der zu befestigende
Gegenstand:**
der Pfosten, die Stele

Fixation des éléments:
le poteau et son
positionnement

Schrauben:
durchgehendes Gewinde,
selbstschneidend

Les vis:
filetage auto-coupant sur
toute la longueur des vis

**Der Pfosten, der «Gotische
Träger» und der Fundamentpfahl
FERRADIX® bilden eine
organische Einheit**

**Le poteau, le support
«GOTHIQUE» et le pieu
FERRADIX®: Obtention d'un
ensemble très soudé**

**Die Schrauben dringen
«gotisch» schräg in
das Pfosteninnere und
durchqueren die Holzfasern**

**L'angle de vissage permet
aux vis de traverser en
biais les nervures du bois**

**Belüftung der Pfostenunter-
seite durch Luftzirkulation**

**Ventilation de la base du
poteau grâce aux trous
d'aération intégrés dans la
base du support «GOTHIQUE»**

**Das Zwischenstück:
der «Gotische Träger»**

L'entretoise:
que constitue le support
«GOTHIQUE»

**Das Fundament:
der Fundamentpfahl FERRADIX®**

La base:
du pieu FERRADIX®

**Der Abstand zwischen
Holz und Boden schützt
vor Feuchtigkeit**

**La surélévation du poteau
protège le bois de l'humidité**

**Garantierter Abstand:
Der «Gotische Träger»
sitzt im Grund auf**

**Le support «GOTHIQUE»
s'insère jusqu'au cône du
pieu FERRADIX® enfoncé
dans le sol, ce qui garantit
la surélévation du poteau**

**STELENSYSTEME
SYSTÈMES TOTEM**

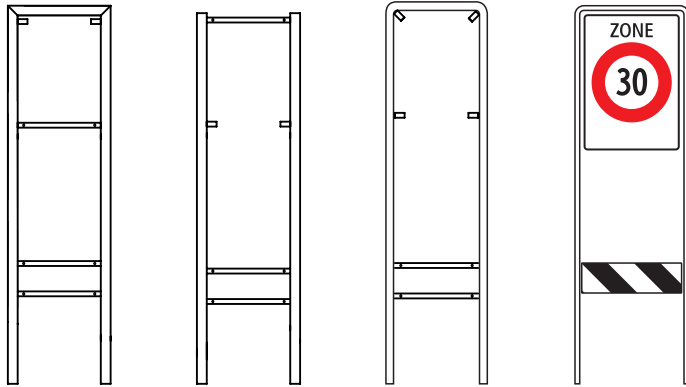

Format: individuell

Beispiele
Exemples



510V 4-Kant/Carré



510R Rundrohr/Tube cylind.



510T T-Stahl/Acier-T

* Preis auf Anfrage
* Prix sur demande

**FACHWERKSTÜTZEN
SUPPORTS TREILLIS**

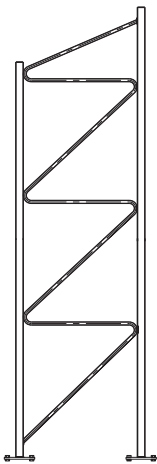

Format: individuell

* Preis auf Anfrage
* Prix sur demande